

Scorpion® Trailer Attenuator



Features

- NCHRP 350 tested and approved for all mandatory and optional offset and angled impacts
- Only Trailer Attenuator, tested and approved when attached to a 10,000 lb host vehicle (caution – forward roll of host vehicle was 64' when impacted by a 4,500 lb truck traveling at 63.5 mph)
- Single point attachment to standard 20 Ton (minimum) rated pintle hook is quick and easy
- Requires little or no modification to host vehicle or additional mounting hardware (1/2" thick x 32" wide minimum pintle hook mounting plate required)
- Telescoping Anti-Rotational System (TARS™) minimizes Scorpion Trailer rotation during angled impacts and prevents trailer separation from host vehicle
- The Scorpion's proven modular design crushes in progressive stages allowing quick and economical replacement of damaged parts
- The unique curved design gives full width protection to the back of the host vehicle and protects the "coffin corners" of the truck
- Rear axle placement improves trailer stability and prevents the tail from "bottoming out" on driveways or uneven surfaces
- Overall length of Scorpion Trailer Attenuator is only 17' 5" – the shortest on the market
- Integrated electric brake system comes standard on Scorpion Trailer – brakes are automatically activated in the event of trailer separation or hitch failure
- Available in a shorter (12' 7") lower speed TL-2 (45 mph) model, which is ideal for congested city streets or where posted speeds are 45 mph or less
- Optional Arrow or Message Board can easily be attached to Scorpion Trailer Attenuator

TraFFix
Devices Inc.



Telescoping Anti-Rotation System (TARS™)

Pre-Impact Condition

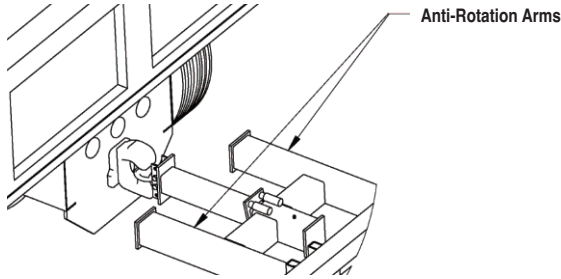

The Scorpion Trailer attaches directly to the pintle hook. It does not require additional installation, or truck modification, beyond standard factory installed pintle hook and 1/2" steel frame plate.

Post-Impact Condition

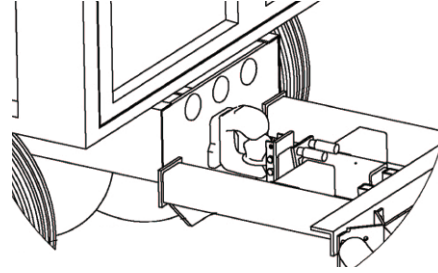

Upon impact, two heavy duty anti-rotation arms are driven against the frame plate, preventing angular rotation of the Scorpion Trailer during an accident.

TL - 3; 3-52 Offset Test — 4,500 lb vehicle impacts 20,000 lb host vehicle at 62.5 mph (100 kph)

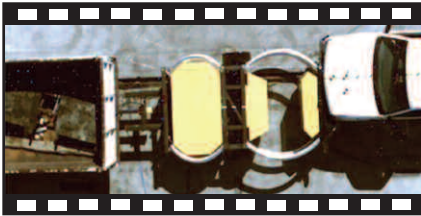

Beginning of impact



Mid-point of impact

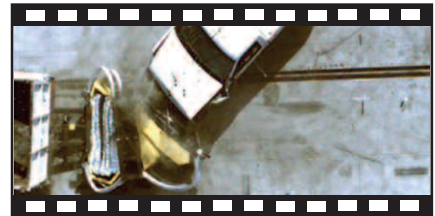

End of impact

**Scorpion®
Trailer Attenuator
1000 Series**

Specifications		TL-2	TL-3
• Length		12' 7"	17' 5"
• Width		96"	96"
• Height		36"	36"
• Weight		1,460 lbs	1,900 lbs

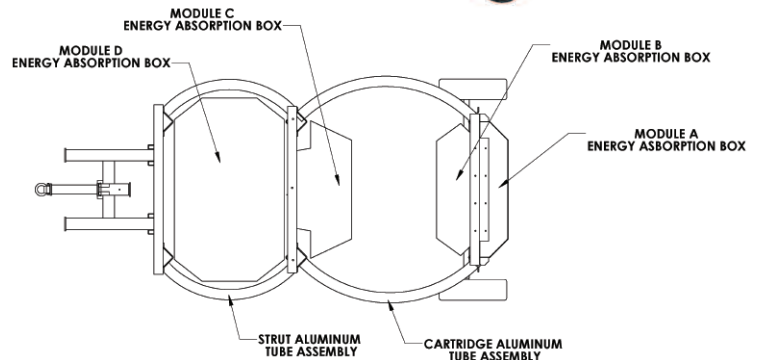
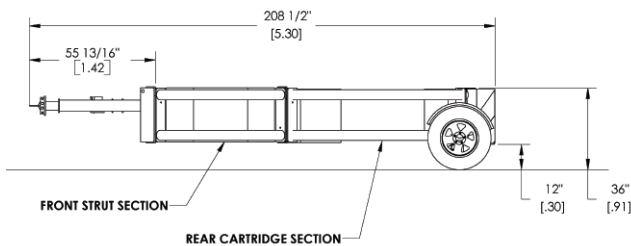
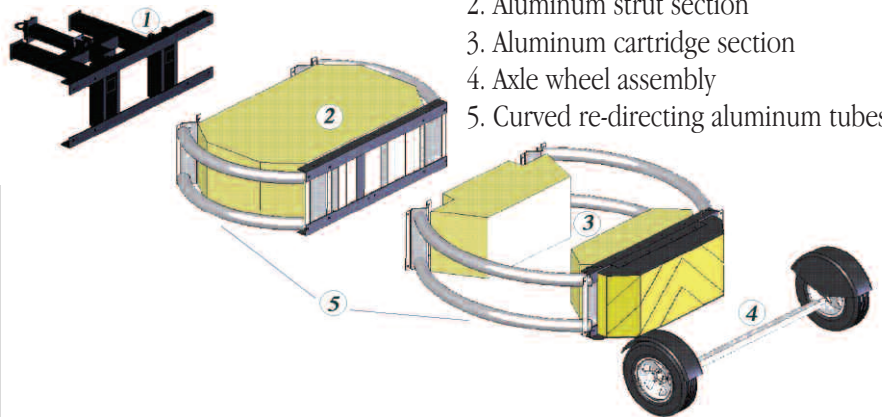

© Copyright January, 2007 Traffix Devices, Inc. Traffix® and Scorpion® are trademarks of Traffix Devices, Inc. U.S. Patent No. 6,024,341 and 6,581,992 B1 Licensed Under U.S. Patents 6,092,949 and 6,481,920



Distributed by:

160 Avenida La Pata, San Clemente, CA 92673
 (949) 361-5663 FAX (949) 361-9205
 www.traffixdevices.com